

TIP STRAP FITTING INSTRUCTIONS

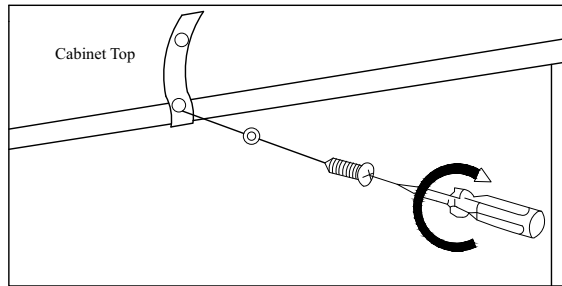

STEP : 2
Make a mark on the wall through the strap .

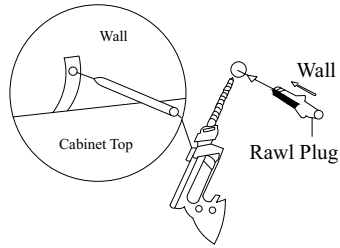

Drill a hole in the wall and insert the rawl plug .

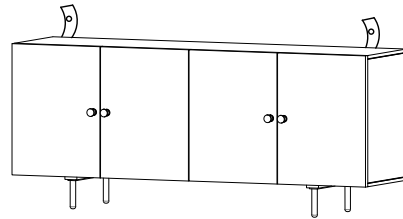

STEP : 3
Insert screw through washer into hole in wall

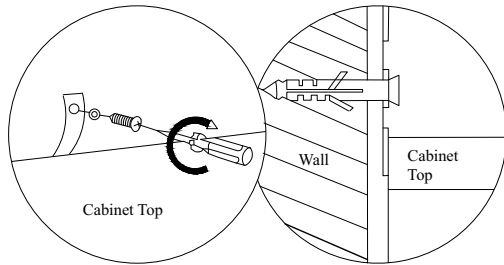

NOTE: Wall Fixings are not supplied with this product as different wall materials require different types of fixing devices (such as Rawl plugs on brick work) You must use fixing devices suitable for the type of wall you intend to mount this product to. Please ensure that the head of any screw used has a diameter greater than the diameter of the mounting hole on the product and that the fixing is safe and secure before use.

The strap and screw which to fix the strap on to the furniture are provided only.

HARDWARE LIST

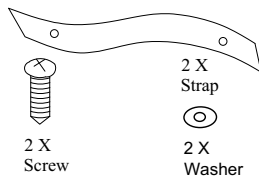

2 X
Screw

2 X
Strap

2 X
Washer

2 X
Washer

ASSEMBLY INSTRUCTIONS

DESCRIPTION:- GINKGO SIDEBOARD

0.25 HOURS

APPROXIMATE ASSEMBLY TIME

2 PERSON ASSEMBLY

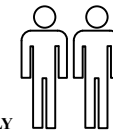

CEILING HEIGHT
3 M

REQUIRED ASSEMBLY SPACE

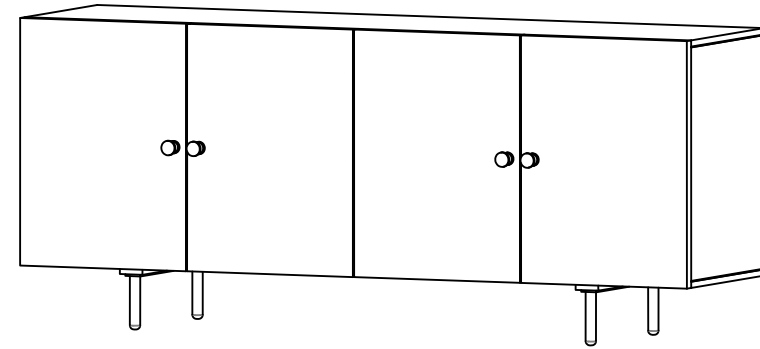

HARDWARE

(H1) 6 Pieces

(H2) 6 Pieces

REQUIRED ASSEMBLY TOOLS

(T1) 1 Piece

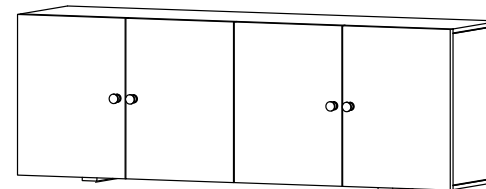

CARCASE :- 1 PIECES

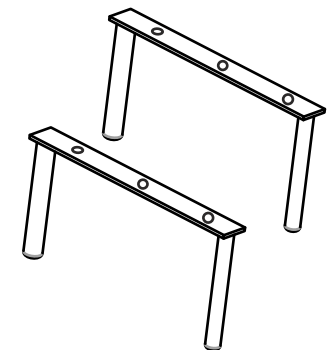

LEGS :- 2 PIECES

STEP - 1

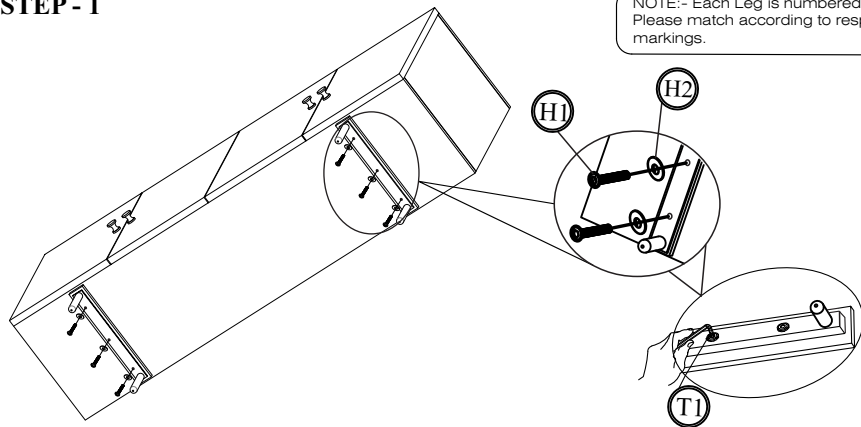



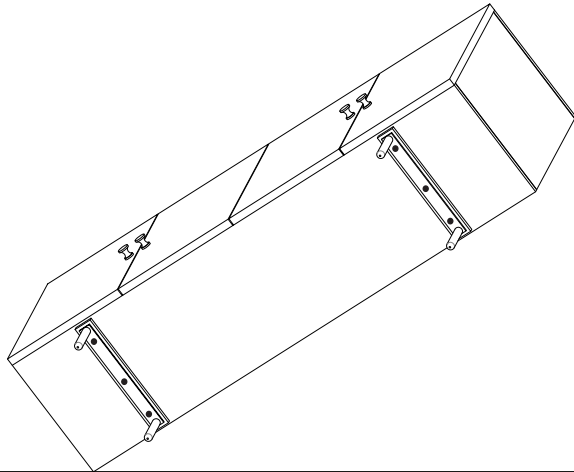



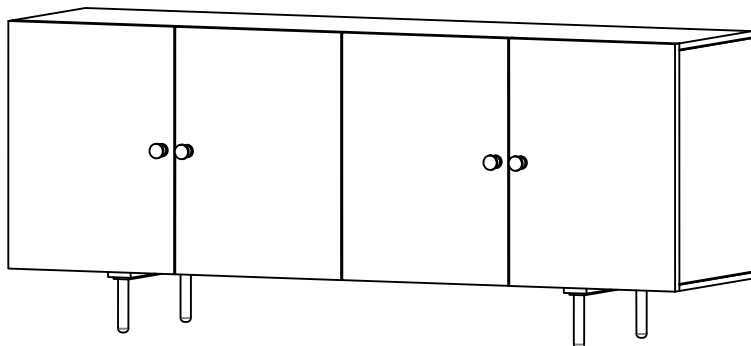









STEP - 2



FINAL PRODUCT



Care & Maintenance

-   Do not put hot items directly on furniture surface.
-   Do not clean furniture with harsh cleansers or polish.
-   Do not place furniture in direct sunlight.
-   Do not place furniture near heating or cooling vents.
-   Do not write on furniture without a padded barrier to protect the surface.
-   Do not place furniture outside. For indoor use only.
-   Dust and pick-up spills using a clean, non-colored, lint-free cloth.
-   Stains may be removed with mild soap solution and damp cloth.